



PROFESSIONAL[®]

SEALERS PVT LTD.

Waterproofing Solutions & Construction Chemicals

**WATERPROOFING SOLUTIONS &
CONSTRUCTION CHEMICALS**

**SPECTITE[®]
PVC/RUBBER
WATERSTOPS
JOINT SEALING
PROFILES**

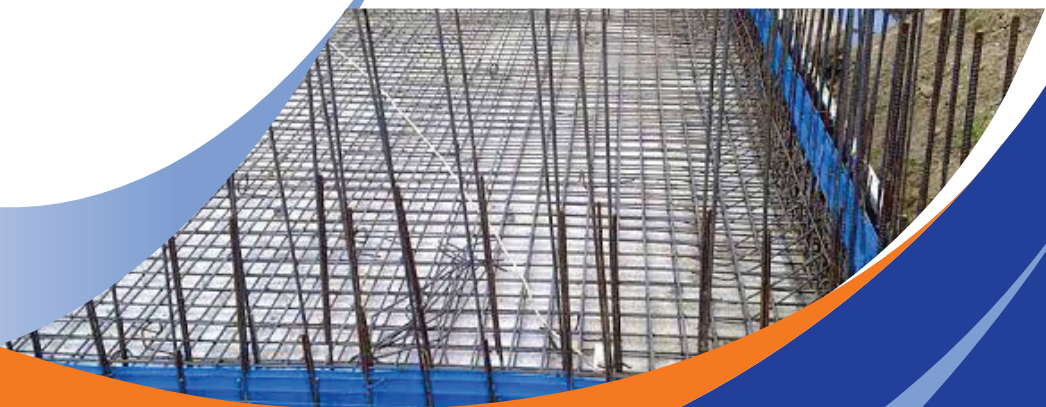

+ 92 42 35463504

www.professionalsealers.com

professional.sealers@gmail.com

PRODUCT DESCRIPTION

SPECTITE® PVC WATERSTOPS lead the way in high technology waterstops and complies with international standards and testing methods: (CRD C-572, ASTM D638, BS 2782, ISO 527, DIN 18541.

SPECTITE® PVC WATERSTOPS are extruded from specially compounded PVC and they are designed for use in water retaining and water excluding structures where a positive seal is required for poured in-situ concrete expansion, construction and contraction joints.

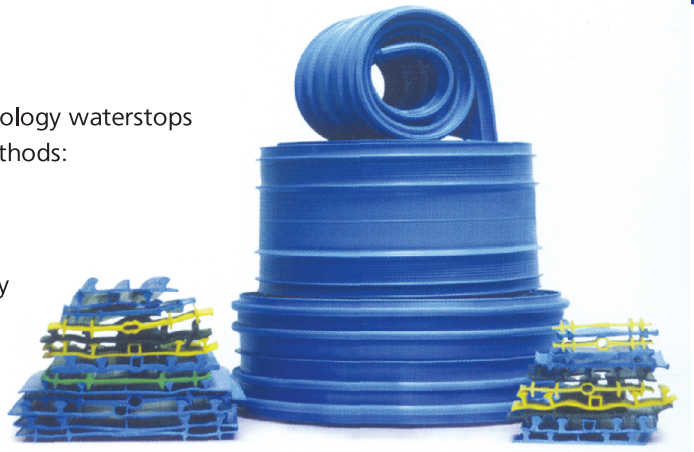

SPECTITE® PVC WATERSTOPS are designed for use in many types of applications and structures, and are available in a number of different size profiles to suit a project's requirement.

SPECTITE® PVC WATERSTOPS are available in rolls with separate intersections supplied to simplify and minimize on-site fabrication. The waterstop is heat weldable and allows for fast and easy on-site welding/joining.

The efficiency of any waterstop is very dependent on good workmanship, installation, and on full compaction of the surrounding concrete around the waterstop during concrete placement. Optimum performance will be achieved if the waterstop is installed by keeping these important factors in mind.

ADVANTAGES

- A full range of profiles and sizes to suit all types of construction requirements.
- **SPECTITE® PVC WATERSTOPS** conform to, and exceed all major international standards.
- High quality compounded PVC for long term durability and integrity.
- Factory made intersections to simplify and minimize on-site fabrication.
- Good chemical resistance and suitable to use in contact with potable water.
- All profiles come with factory pre-punched reinforced eyelets for easy and secure wire tying to reinforcement.
- Ability to withstand high hydrostatic head pressures.
- Environmentally friendly (lead-free) formulation.
- Can be use in hot and cold climates.

AREAS OF APPLICATION

Water retaining structures:

- Water tanks
- Water treatment plants
- Sewage treatment plants
- Swimming pools
- Dams and spillways
- Reservoirs
- Bund walls

Water excluding structures:

- Basements
- Underground car parks
- Tunnels
- Retaining walls
- Suspended slabs
- Below ground slabs
- Roof & podium slabs

Note: The products design and performance, its intended use, installation and final confirmation and approval for use, must be provided by the project's Design Engineer and Project Manager.

PHYSICAL PROPERTIES

PROPERTY	TEST METHOD	RESULT
Tensile Strength (N/mm ²)	BS 2782 : 320A, ISO 527, D 412	≥ 14
Elongation At Break (%)	BS 2782 : 320A, ISO 527, D 412, D 638	≥ 300
Water Absorption at 23°C (%)	ISO 62, D 570	0.06
Specific Gravity (g/cm ³)	BS 2782 : 620B, ISO 1183, D 792	1.38 ± 0.02
Low Temperature Brittleness	ASTM D746	Passes @ -37° F
Hardness, Shore A	BS 2782:365A, ISO 868, D 2240	78 ± 2
Fire Resistance	DIN 4102-1	B2
Tear Resistance (kN/m)	D 624	≥ 92

All values given are subject to 5-10% tolerance.

Note: Professional Sealers Pvt. Ltd. in house Certificate of Analysis (COA) is conducted on every batch of raw material that is used in the Production of SPECTITE® PVC WATERSTOPS. Independent laboratory test results are also available upon request.

PROFILE DRAWINGS

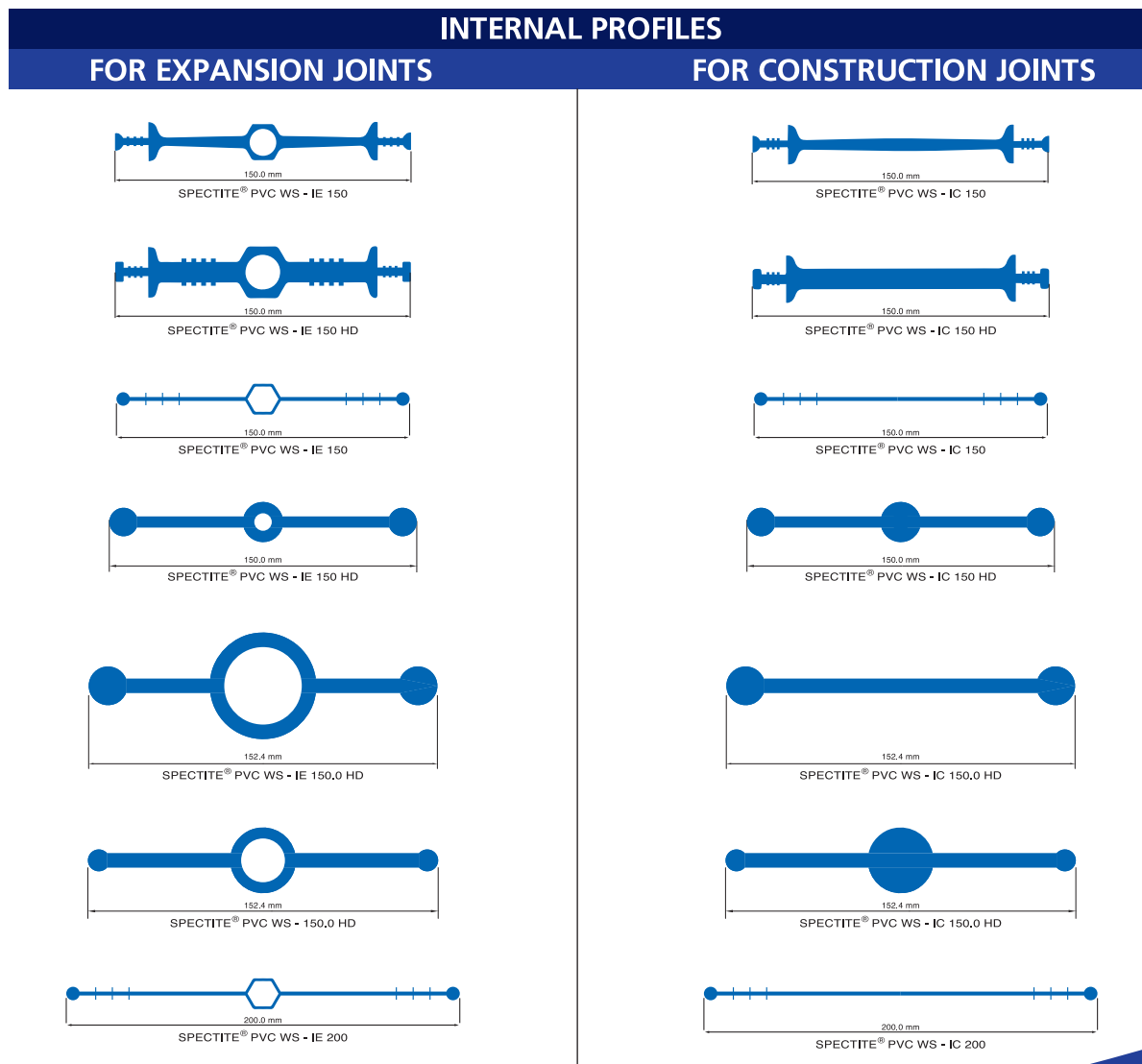

PROFILE DRAWINGS

INTERNAL PROFILES

FOR EXPANSION JOINTS

FOR CONSTRUCTION JOINTS

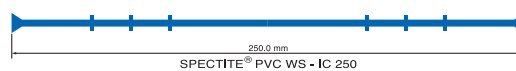
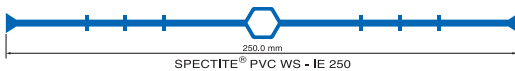
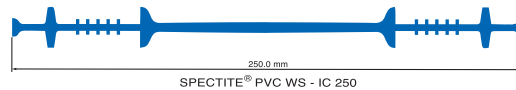
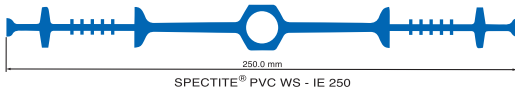
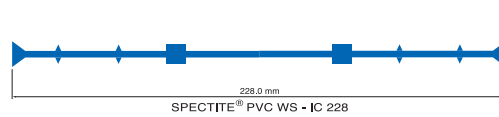
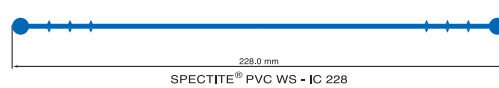
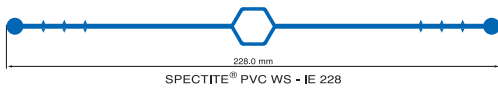
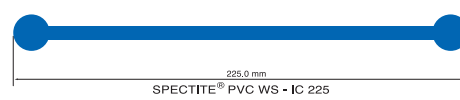
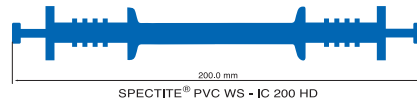
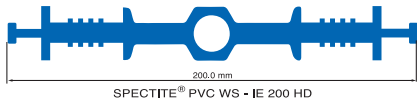
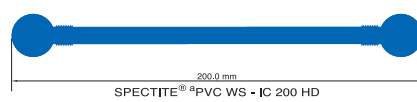
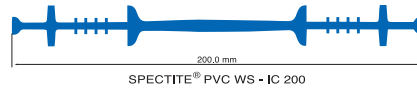
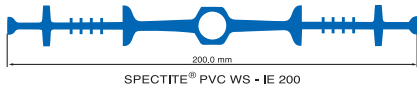
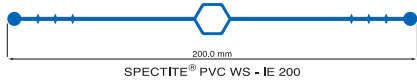

PROFILE DRAWINGS

INTERNAL PROFILES

FOR EXPANSION JOINTS

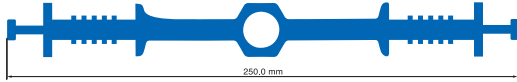

SPECTITE® PVC WS - IE 250 HD

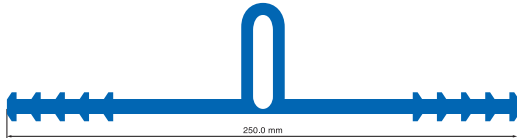

SPECTITE® PVC WS - IE 250 HD

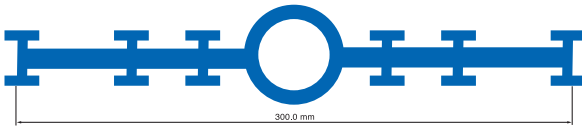

SPECTITE® PVC WS - EE 300 HD



PVC WS - IE 330



SPECTITE® PVC WS - IE 330 HD



SPECTITE® PVC WS - IE 320



SPECTITE® PVC WS - IE 400

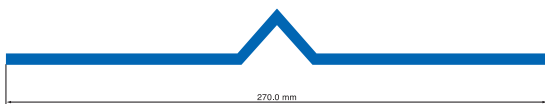

SPECTITE® PVC WS - IE 270

FOR CONSTRUCTION JOINTS

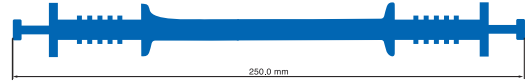

SPECTITE® PVC WS - IC 250 HD



SPECTITE® PVC WS - IC 250 HD

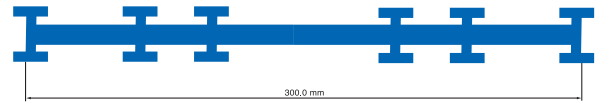

SPECTITE® PVC WS - EC 300 HD

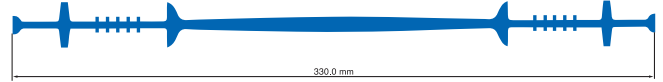

SPECTITE® PVC WS - IC 330

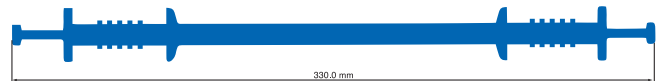

SPECTITE® PVC WS - IC 330 HD

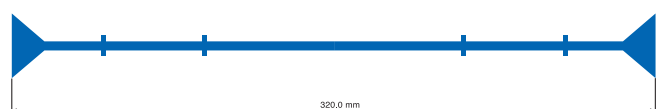

SPECTITE® PVC WS - IC 320

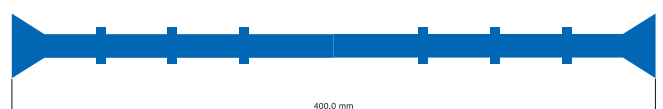

SPECTITE® PVC WS - IC 400

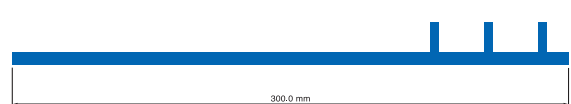

SPECTITE® PVC WS - EC 300 HD

PROFILE DRAWINGS

EXTERNAL PROFILES

FOR EXTERNAL EXPANSION JOINTS

FOR EXTERNAL CONSTRUCTION JOINTS

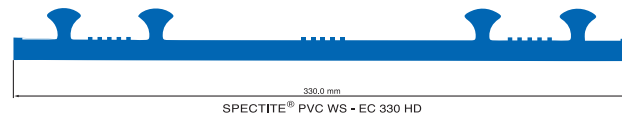
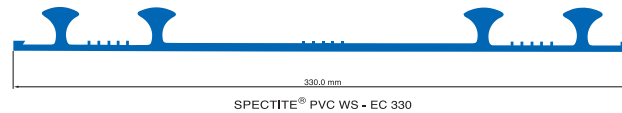
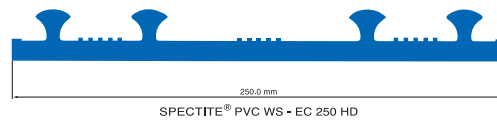
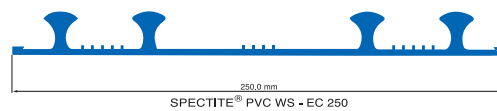
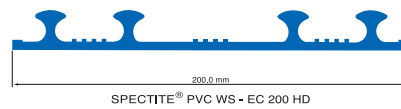
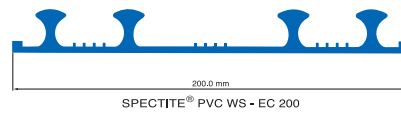
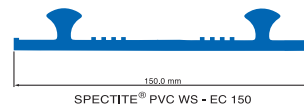
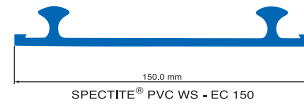
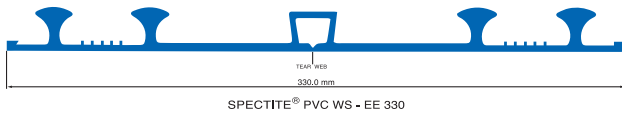
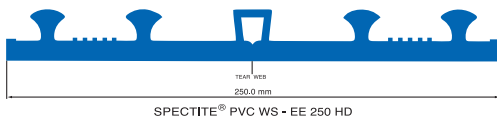
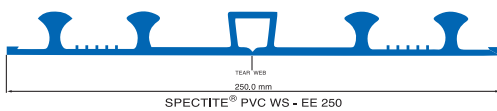
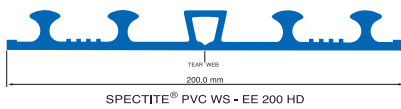
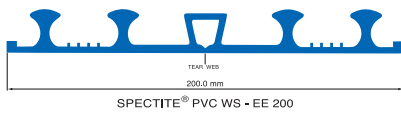
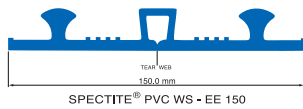
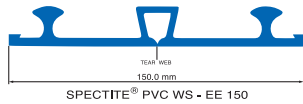

Note: Upon request any profile of **SPECTITE® PVC/RUBBER** waterstops can produce. Detailed/customized dimensional drawings are available upon request. More than 300 profiles are available of **SPECTITE® PVC/RUBBER** waterstops.

TYPICAL APPLICATIONS

EXPANSION JOINT

CONSTRUCTION JOINT

STANDARD DETAIL OF WALL APPLICATIONS

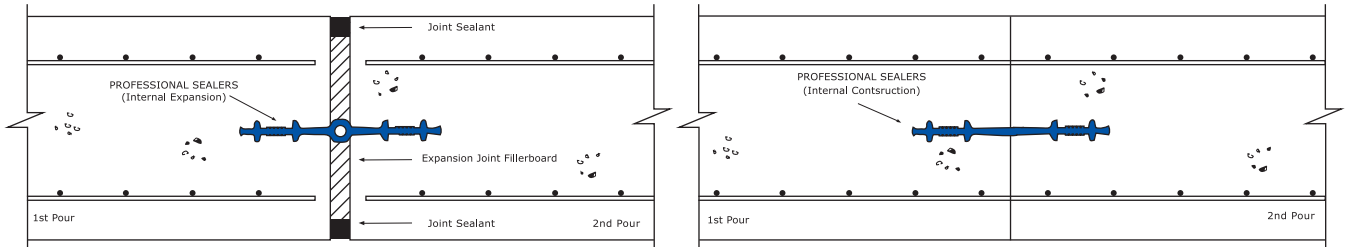

STANDARD DETAIL OF GROUND SLAB APPLICATIONS

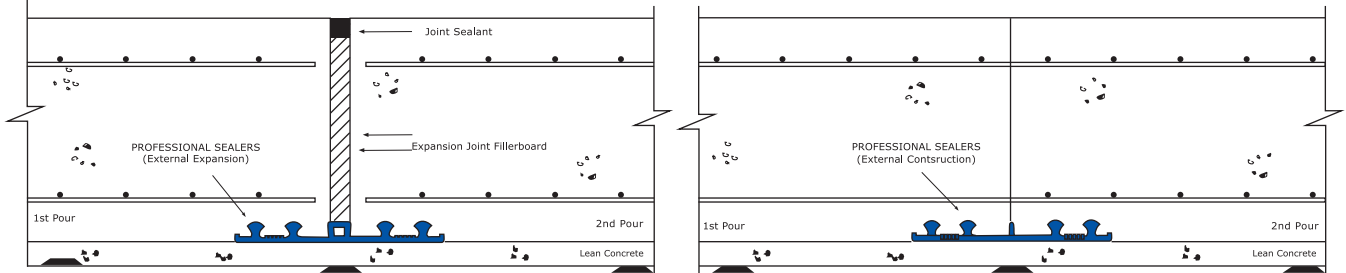

STANDARD DETAIL OF TEAR WEB, SPLIT FLANG & RETROFIT

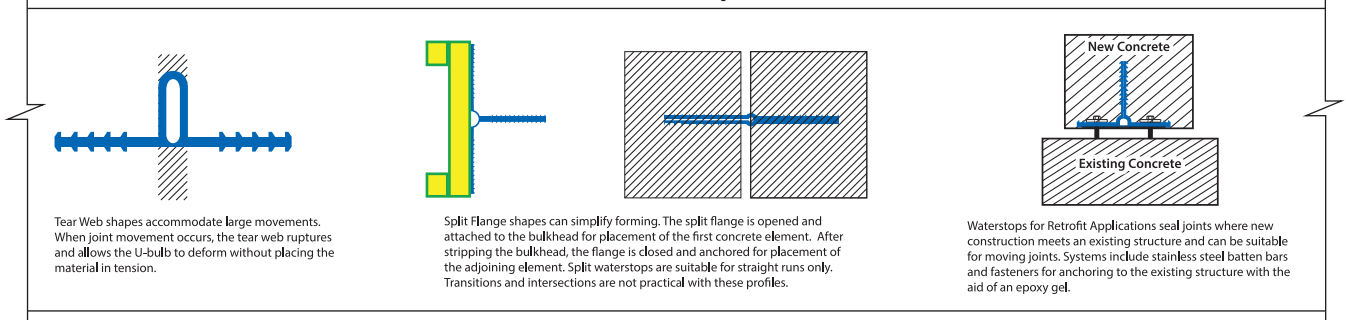

TECHNICAL FEATURES

COLOR

PACKAGING

ROLL WEIGHT

STORAGE CONDITIONS & SHELF LIFE

MATERIAL TYPE

WELDING TEMPERATURES

SERVICE TEMPERATURE RANGE

HYDROSTATIC HEAD PRESSURE

Blue, Beige, Yellow, Black and other colors are available on request.

(150 & 200) mm Profiles = 30rmts roll. (150 & 200) mm HD profiles = 15m roll.

(250 & 330) mm Profiles = 30rmts roll. (250 & 330) mm HD profiles = 15m roll.

Dependent upon profile type.

5 years from the date of production if stored properly in original,

unopened, undamaged sealed packaging and in dry conditions out of direct sunlight at temperatures between +10 °C and +40 °C, keep away from sharp edges to prevent damage.

Polyvinyl Chloride (PVC)

Approximately +200°C

-40°C to +80°C

Up to 100m (13 bar)

PROFILE WIDTH SELECTION

The width of waterstop depends upon the thickness of the concrete and positioning of the reinforcement. The thickness of the concrete should be greater than or equal to the width of the waterstop profile. Refer to your engineer for further clarification and approval.

SITE JOINTING

PROFESSIONAL SEALERS Pvt. Ltd. recommends to use of its specialized welding equipment for on-site welding which consists of welding tools and special welding jigs. On-site joining is a simple exercise using **PROFESSIONAL SEALERS** Heat Welding Equipment comprising of an adjustable welding jig and welding tool. The ends of the waterstop are cut square and placed into the adjustable welding jig, then push the ends of the waterstop against the Welding tool and bring the two ends together until the molten ends of the PPVC fuse.

FACTORY MADE INTERSECTIONS

A wide range of standardized prefabricated intersection pieces are available allowing easy site welding of butt joints to **PROFESSIONAL SEALERS Pvt. Ltd.** intersection pieces. Customized pieces can be made to suit. In such cases, drawings must be provided giving exact dimensions and jointing details.

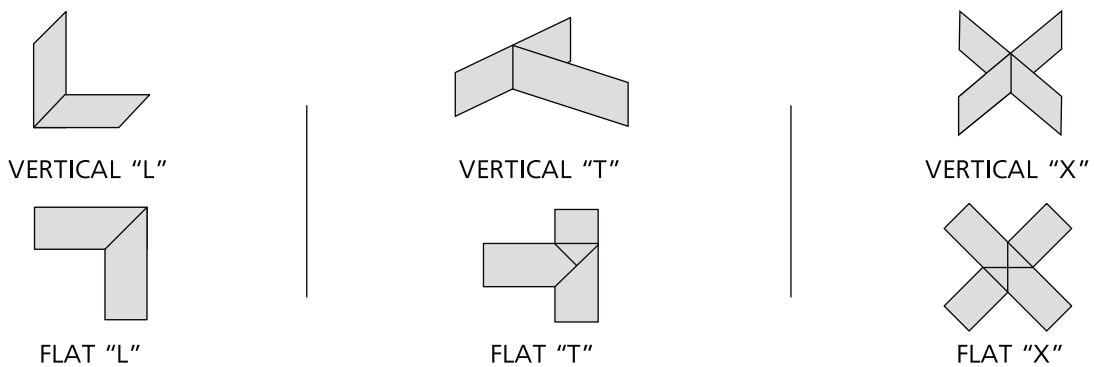

WRITTEN SPECIFICATION

Where shown on the drawings waterstops shall be **SPECTITE® PVC WATERSTOPS** (state profile required) as supplied by **PROFESSIONAL SEALERS Pvt. Ltd.** Provide factory made waterstop fabrications for all changes of direction, intersections and transitions, leaving only straight butt joined splices for on-site fabrication.

HEALTH AND SAFETY INFORMATION

Joining of PVC Waterstops is performed by heat welding which results in the discharge of hydrogen chloride mist and vapor. The OEL (operational exposure limit) of 5 ppm can be exceeded in confined spaces or in still air conditions, the ventilation fan or suitable respirator should be used, and the advice and approval of the Site Safety Supervisor is essential. For further information or advice on health and safety precautions, safe handling, storage and correct disposal of products, please refer to the most recent Material Safety Data Sheet (MSDS), which is available upon request.

DISCLAIMER

The information and the recommendations relating to the application and end use of this product are given in good faith and are based on the information provided by the manufacturer of the product and/or the Company's current knowledge and experience in connection with the product when properly stored, handled and applied under normal conditions and no liability of final function at the job site is assumed. In practice, the differences in materials substrates and actual site conditions are such that no warranty in respect of merchantability of or fitness for particular purpose, nor any liability arising out of any legal relationship whatsoever, can be inferred either from this information, or from any written and/or oral recommendations, or from any other advice offered by the Company. The Company also has no express or implied knowledge of any particular purpose for which the product is required and any such information given will not be taken into account in the supply of this product. No responsibility or liability by the Company will be accepted for misuse, misreading or derivation from recommended guidelines in respect of this product and the user shall determine the suitability of the product for his intended use and assume all risks and liability in connection therewith. The information contained in our brochure may change at any time without notice. Any use of this product; **PROFESSIONAL SEALERS Pvt. Ltd.** in any application should be approved as suitable for use/application by the Design Engineer and Project Manager.





PROFESSIONAL[®]
SEALERS PVT. LTD.
Waterproofing Solutions & Construction Chemicals

Distributed BY



+ 92 42 35463504

www.professionalsealers.com

info@professionalsealers.com